

Ultrasonic Heat Meter 2WR5

Configuration

UH 102-101k

Safety instructions

- ☞ Never hold and transport the heat meter by the calculator but only by the flanged or threaded joint.
- ☞ Pay attention to sharp edges (thread, measuring pipe).
- ☞ Calibration, maintenance, replacement of components, and repairs must only be performed by a qualified person familiar with the hazards involved.
- ☞ Assembly and dismantling may be carried out only in a pressureless plant.
- ☞ After the installation the tightness must be proved by pressurizing with cold water.
- ☞ Use meter only under the specified operating conditions. Otherwise dangers may arise and the warranty expires.
- ☞ Calibration-related seals of the heat meter may not be damaged or removed! Otherwise, the warranty of the heat meter becomes void.
- ☞ The regulations for electrical installations must be complied with!
- ☞ Return of the Lithium batteries must be carried out professionally.
- ☞ A lightning protection cannot be ensured; this has to be made sure through the house installation.

General

2WR5 heat meters are used to measure heat consumption in district heating networks and in multi-family houses. It can be used for cold measurement at the same time (solely or together with heat measurement) or for pure flow measurement in systems using water as the medium.

Meas. accuracy EN 1434 Class 2 or 3

Calculator

Storage temperature - 20 to 60°C
 Ambient temperature 5 to 55°C
 Ambient humidity < 93 % r.H.
 Degree of protection IP 54 acc. to EN 60529
 Safety class 230 V line II acc. to EN 61558
 24V AC line III acc. to EN 61558
 Switch-off limit for ΔT 0,2 K
 Temperature difference $\Delta T = 3 \text{ K bis } 120 \text{ K}$
 Temperature range 2...180°C

Sensors

Type Pt500 or Pt100 acc. to EN 60751
 Temperature range 0...150°C length < 45 mm
 0...180°C length > 100 mm

All volume measuring parts

Installation location Return or supply
 Installation orientation Horizontal or vertical
 Flow straightening none
 Metrological class 1:100
 Temperature range 10 to 130°C
 Maximum temperature 150°C for 2000 h
 Maximum overload 2.8 x q_p
 Nom. pressure **PN16, PN25**

Nominal flowrate q_p	Mounting length	Connection	Maximum flow q_m	Minimum flow q_l	Operating limit	Pressure drop at q_p	Kv-Flowrate at $\Delta p 1$ bar	Kv-Flowrate at $\Delta p 100$ mbar	Weight t (F *)
m³/h	mm	G / DN	m³/h	l/h	l/h	mbar	m³/h	m³/h	kg
0.6	110	G 3/4	1.2	6	2.4	150	1.5	0.5	1
0.6	190	G 1 DN20	1.2	6	2.4	150	1.6	0.5	1.5 3
1.5	110	G 3/4	3	15	6	175	3.6	1.1	1
1.5	190	G 1 DN20	3	15	6	150	3.9	1.2	1.5 3
2.5	130	G 1	5	25	10	200	5.6	1.8	1.5
2.5	190	G 1 DN20	5	25	10	200	5.6	1.8	1.5 3
3.5	260	G 1 1/4 DN25	7	35	14	65	13.7	4.3	3 5
6	260	G 1 1/4 DN25	12	60	24	152	15.4	4.9	3 5
10	300	G 2 DN40	20	100	40	120	28.9	9.1	4 7
15	270	DN50	30	150	60	120	43.3	13.7	8
25	300	DN65	50	250	100	105	77.2	24.4	11
40	300	DN80	80	400	160	150	103	32.7	13
60	360	DN100	120	600	240	115	177	56	22

Small heat meter

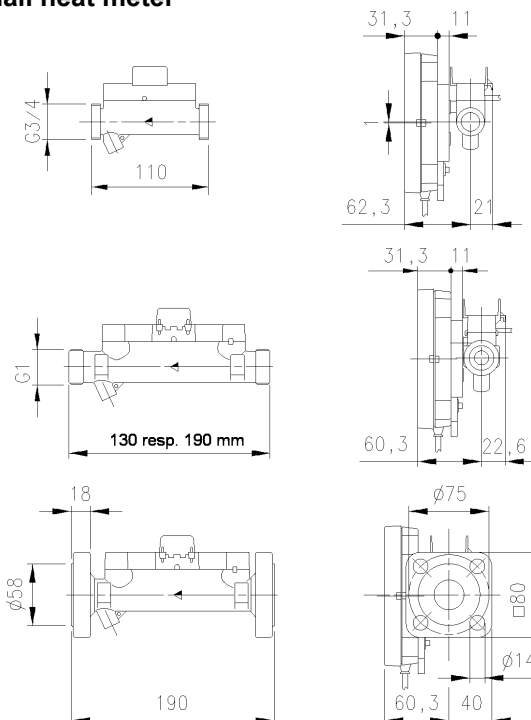

Large heat meter with threaded joint

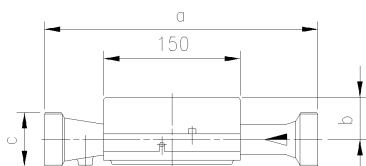

order no.	qp m³/h	PN bar	a	b	c
2WR5 45	3.5	16	260	51	G 1¼ B
2WR5 50	6	16	260	51	G 1¼ B
2WR5 60	10	16	300	48	G 2 B

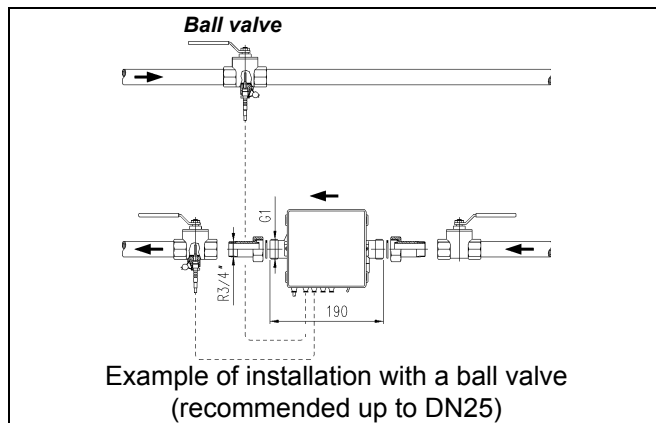

Large heat meter with flanged joint

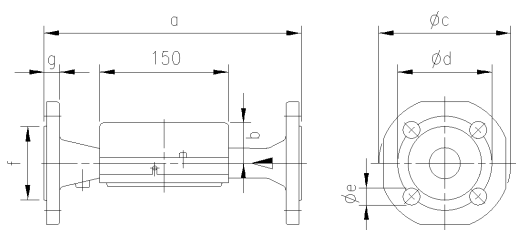

order no.	qp m³/h	PN bar	DN	a	b	øc	ød	øe	no. of holes	f	g
2WR5 46	3.5	25	25	260	51	115	85	14	4	68	18
2WR5 52	6	25	25	260	51	115	85	14	4	68	18
2WR5 61	10	25	40	300	48	150	110	18	4	88	18
2WR5 65	15	25	50	270	46	165	125	18	4	102	20
2WR5 70	25	25	65	300	52	185	145	18	8	122	22
2WR5 74	40	25	80	300	56	200	160	18	8	138	24
2WR5 82	60	16	100	360	68	235	180	18	8	158	24
2WR5 83	60	25	100	360	68	235	190	22	8	158	24

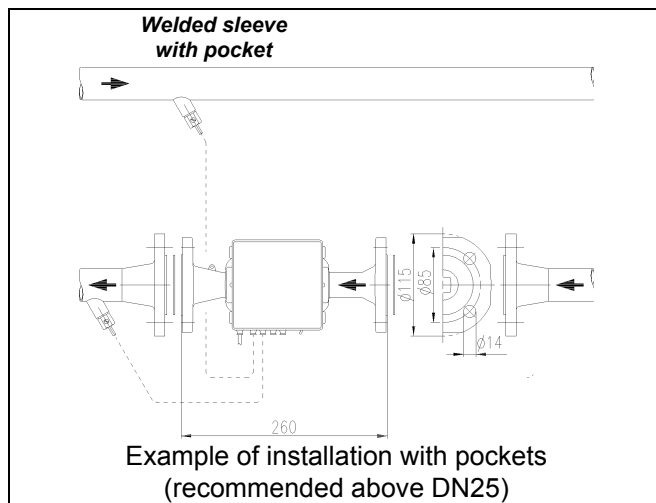

Cavitation must be prevented by overpressure in the entire measuring zone, i.e. at least 1 bar for q_p and approx. 3 bar for q_s (at 80°C).

When used as cold meter:

- install meter in return only
- use split version only (avoid condensation)

Installation

Select an installation location with sufficient clearance using the dimension drawings and install the volume measuring part between 2 shut-off valves such that the arrow on the volume measuring part points in the direction of flow.

No straight pipe sections are necessary before and after the meter. If the meter is installed in the common return of two heating circuits, e.g. heating and hot water, select an installation location that is far enough, i.e. min. 10 x DN, from the T joint for the different temperatures of water to mix thoroughly.

The sensors can be installed in T joints, ball valves, direct immersed or in pockets. The end of the sensors must extend in any case as far as the centre of the pipe cross-section.

Display

The heat meter display is subdivided into several levels and may differ from the standard shown below. The user loop display (level 1) is advanced cyclically each time the button is pressed briefly.

User loop

1594967 MWh	Accum. qty of thermal energy
00 12456 MWh	Tariff register, here, e.g. cold
1307148 m³	Accumulated volume
888888 MWh	Segment test
F - - - - -	Error with/without error digit

The tariff displays can vary depending on the tariff type. The displays shown here are for a combined heat/cold meter. The valid tariff status is displayed together with the thermal energy as $_$, $=$ or \equiv . With a **pure flow meter** the heat and tariff registers are not displayed.

If button is held pressed for three seconds, the display switches from the user loop to the service loops (level 2).

Service loops

L.OOP 1	Service loop 1
L.OOP 2	Service loop 2
L.OOP 3	Service loop 3

One of the service loops is preselected by pressing the button briefly. By pressing the button for another 3s the contents of the selected service loop will be displayed.

Each time the button is pressed briefly the next information is displayed.

The service loops are exited by holding the button pressed for 3s or automatically after 30 minutes.

Service loop 1 („LOOP 1“)

8,324 m ³ /h	Current flowrate
306 kW	Current heat output
92 55 °C	Current flow and return temperature
T9 00020 °C	Threshold value for the tariff, e.g. Tv
K0000000	Property number, 7-digit
D 15,1004	Date
S 0 10 1--	Annual set day (dd.mm) *)
V 1594967 MWh	Heat for previous year on set day *)
E 00 12,456 MWh	Tariff register for previous year on set day *)
V 1307148 m ³	Volume for previous year on set day *)
2-03 FW	Version of firmware

*) see restrictions regarding set day under "Fast pulses" page 5

Service loop 2 („LOOP 2“)

In service loop 2 the **monthly values** are displayed. One of the previous 36 monthly values can be selected by pressing the button briefly. The corresponding data are then opened by pressing the button for 3s. Each time the button is pressed briefly the next value for the selected month is displayed.

0 10904 M	Set day previous month Sep. 2004
0 10804 M	Set day previous month Aug. 2004
...	Set day previous xxxx 200y

pressing the button for more than 3s: ↓

1594967 MWh	Qty of thermal energy on this set day
E 00 12,456 MWh	Tariff register on this set day, e.g. cold
1307148 m ³	Volume on this set day
M 8,324 m ³ /h	Max. flowrate in Jul. 2004, changing with date stamp every 2s
S 0 10704 M	
M 306 kW	Maximum heat output in Jul., changing with date stamp every 2s
S 0 10704 M	

M 95 65 °C	
S 0 10704 M	
S 0 10704 M	
F 0 h	

Max. temperatures in Jul., changing with date stamps of flow and return every 2s

Status of missing hour counter on this set day

After the last item is shown, the current set day is again displayed. The next set day can be selected by pressing the button briefly.

Service loop 3 („LOOP 3“)

P1 -----Wh/l	Parameter of fast pulses, significance of energy pulses
P2 ----- l/l	Significance of volume pulses
P3 --- ms	Pulse length in ms
TP 30 SEC	Interval of temperature measurement
---,--- F0	Date stamp for F0 warning
Modul MB	Type of built in module
F 0	M-bus primary address **)
F0000000	M-bus secondary address **)

**) only shown if module is of type MB

Monthly values

The calculator stores for 36 months at the set day at 00:00h the values of:

- Heat (meter reading)
- Tariff (register reading)
- Volume (reading)
- Max. flowrate (monthly maximum averaged across the measurement period, standard 60 min), with date stamp
- Max. demand (monthly maximum averaged across the measuring period), with date stamp
- Max. temperatures (monthly maximum) with date stamp each for flow and return
- Missing time counter

The monthly values can also be read out via the optical and 20mA interface.

Resolution of the display

	1	kWh	up to q _p	10
heat	0,001	MWh	up to q _p	10
	0,01	MWh	from q _p	15
volume	0,01	m ³	up to q _p	15
	0,1	m ³	from q _p	25
heat output	0,1	kW		
temperature	1	°C		
temperature difference	0,1	K		

Power supply

Either batteries or power supply modules can be used for the power supply, that can be upgraded or retrofitted at any time.

Lithium batteries

Voltage	3,6 V
Battery life	see table below
Ambient temperature	maximal 55°C

	used type of battery:			
	C cell	D cell		
	6 year battery	6 year battery	11 year battery *	16 year battery*
Modus:				
standard functions	√	√	√	√
„short T intervall“	√	√	√	not allowed
„fast pulses“	not allowed	√	√	
„fast M-Bus readout“ **		√	not allowed	
with radio module		√	not allowed	
with analogue module		√	not allowed	

* 11 or 16 years when meter is set accordingly ex factory

** applies for switching via command in case of M-Bus module WZR-MP-30

Common features of the power supply modules

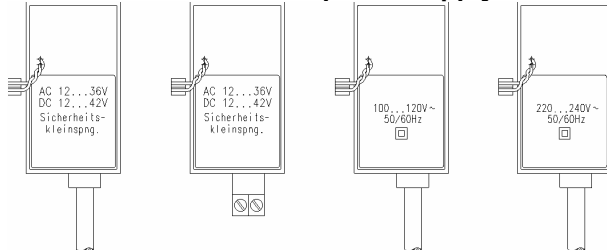

Ambient temperature	5 ... + 50°C
Storage temperature	- 20 ... + 60°C
Cable length	1.5 m or clamp

24 V safety extra-low voltage

Voltage	12..36 V AC or 12..42 V DC
Frequency	50 / 60 Hz or DC
Galvanic isolation	1000 V DC
Power consumption	up to 1.3 VA
Power reserve	15 minutes

100..120 V resp. 220..240 V power supply unit

Type	Protection class II
Frequency	50 / 60 Hz
Line voltage fluctuations	max. 10% of the nom. voltage
Overvoltage category per EN60010	II
Power consumption	2500 V impulse voltage
Power consumption	up to 1.6 VA
Relative humidity	less than 93% for T < 50°C
Maximum altitude	2000 m MSL
Fuse protection	6 A MCB

Interfaces of the Calculator

2WR5 heat meters are all equipped with an optical interface to EN 61107 as a standard. In addition, one of the following **communications modules** can be added for remote readout:

- **Pulses (heat and volume/cold/meter status)**, isolated, bounce-free
- **Passive 20mA current loop (CL)** to EN 61107
- **Combination of pulses and 20mA current loop**
- **M-bus to EN 1434-3**, fixed and extended variable protocol (also for connection to a suitable heating controller)
- **Combination M-bus and pulse output**
- **Modem module**
- **Analog module**
- **Radio module**

These modules do not affect acquisition of the consumption and can therefore be retrofitted at any time without affecting the calibration mark.

Pulse module

In the **standard version CV** (count volume), pulses are output for the quantity of heat (term.16, 17) and volume (18,19), e.g. to operate the roller registers.

In the **RI version** (ready indication) pulses are still output for the quantity of heat but the second optocoupler output signals the operating states "Ready / Fault".

In the **CT version** (count tariff) pulses are output for the quantity of heat (total) and of the heat accumulated in the tariff register (e.g. cold or threshold tariff 1, at terminals 18, 19).

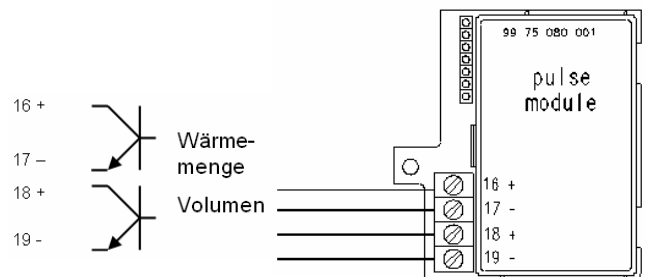

Labelling
Standard
optional
optional

pulse module
CV (count volume)
RI (ready indication)
CT (count tariff)

Type
Connection

open collector
2 × 0.75 mm² each with galvanic isolation

Voltage
Current
Classification
Voltage drop
Dielectric strength

up to 30 V DC
up to 30 mA
OB (acc. to EN 1434-2)
approx. 1,3 V at 20 mA
500 V_{rms} against ground

Pulses for quantity of heat and volume

Period duration > 200 ms
 Pulse duration 100 ms conducting

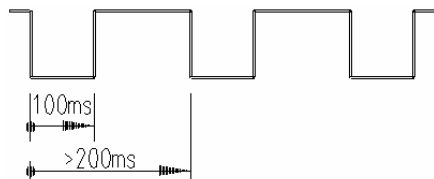

Pulse significance (standard)

q _p m ³ /h	Pulse significance			
	Quantity of Heat		Volume	
	kWh	oder	MJ	
0,6	1		1	0,1
1,0				
1,5				
2,5			10	
3,5				
6				
10	10		1	
15				
25				
40				
60				

Pulses for remote fault signalling:

Ready Pulsed "conducting", i.e.
 100 ... 250 μs pulse duration,
 500 ms period

Fault Steady "not conducting "

Fast pulses

(battery use for 6 and more years requires a D-cell)

For applications such as operation of controllers or

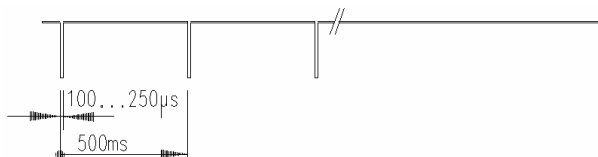

as flow meter, higher pulse rates are required. For that purpose, the same pulse module is used but only one pulse output is actuated (terminals 16 and 17). Parameters, such as the pulse significances, can be configured with the PappaWin software after pushing the service button for 3s (until meter firmware version 2.03 only via pushing the calibration button).

The maximum pulse frequency is 33 Hz (e.g. at a flowrate of q_s).

The following settings can be made:

- Type of pulse: (linear) control pulses or scaled control pulses ***)

- Pulse output: only energy / only volume / higher pulse frequency of both
- Pulse duration: as of 2 ms up to 100 ms in steps of 1 ms

The pulses can be received and evaluated with a suitable device. The settings must be made in accordance with the data given in the data sheet of the controller in question.

***) Scaled control pulses are characterized by the fact that for a nominal value (=100%) specified by the user for the flowrate and demand 75 pulses/minute are always output. The heat meter itself sets upper and lower limits on the pulse rate, 90 pulses/min (120%) and 7.5 pulses/min (10%) respectively. Because pulses are output continuously, the controller receiving the pulses can detect a connection error.

*) **Attention:** With meter firmware versions 2.12 and 2.13 the fast pulses must not be used together with the yearly set day function (see footnote on page 3; can be checked by using PappaWin software from version 1.55).

CL module

With the CL module it is possible to read the heat meter remotely in a point-to-point connection, e.g. meter reading from the front door of the building.

Display on LCD	CL (current loop)
Standard	acc. to EN 1434-3
Type	passive current loop
Baudrate	2400 Baud, fixed
Isolation	galvanic
Connection	2-wire, 2 × 0.75 mm ²
Polarity	yes
Voltage	30 V maximal
Current	30 mA maximal
Voltage drop	< 2 V at 20 mA
Literature	TKB 3415

Example:

Meter reading via handheld terminal

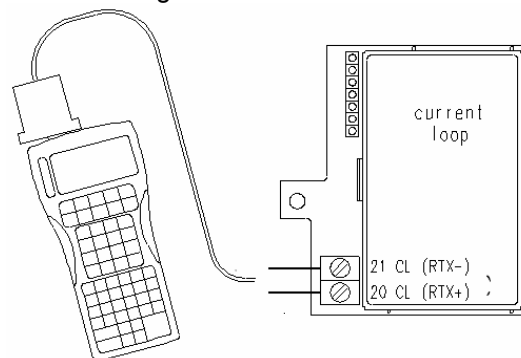

Data content

Updating on each read-out, property number, unit number, firmware version number, fault messages, time of downtime, time of operation, quantity of heat, tariff, volume, installation location, calibration values, meter configuration data, measuring zone, M-BUS addresses, system date and time, previous year's values with set day for heat, tariff and volume, power maximum, fault duration, 36 monthly values for

quantity of heat, tariff, volume, time of downtime, power maximum, flow rate maximum, measuring period with maxima for power, flow rate and temperatures, actual values for power, flow rate and temperatures.

Combi module CL + Pulse

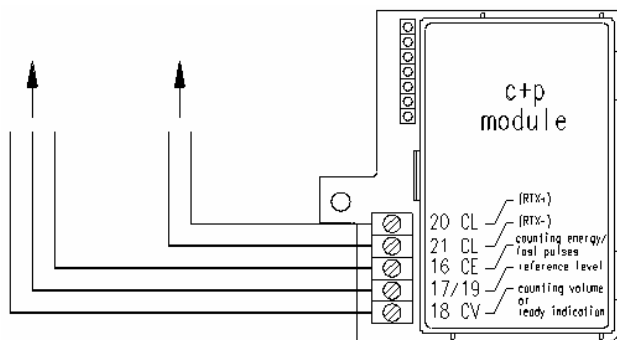

In the C + P combi module, the functions of both the pulse module (terminals 16,17,18) and the CL module (terminals 19, 20, 21) are implemented. Please note that the reference potentials 17, 19 are assigned to a common terminal.

This module delivers only standard pulses and not the so called fast pulses.

M-Bus-Module

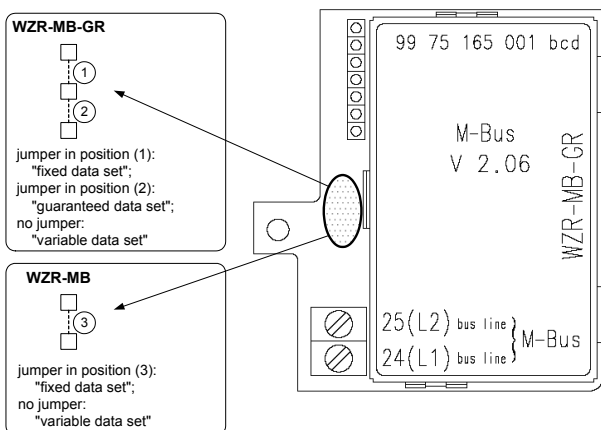

With the bus module it is possible to read several heat meters from a central location.

Display on LCD	MB (M-Bus)
Standard	acc. to EN 1434-3
Isolation	galvanic
Connection	2 × 0.75 mm ² with galvanic isolation
Voltage	50 V maximal
Current consumption	1.0 M-Bus loads (1, 5 mA)
Addressing	primary or sekundary
Transfer rate	300/1200/2400/4800 Baud
Literatur	TKB 3417
frequency of readout	any, also with battery

Data with the fixed data set:

Updating every 15 minutes;

Property number, quantity of heat, volume, setting and resetting of a user protection, setting of the date and time, setting of the primary and secondary address.

Data with the variable/guaranteed data set:

Updating every 15 minutes *)

Property number, unit number, manufacturer ID, medium, firmware version, fault messages, missing time, operating time, quantity of heat, tariff register, volume, previous month's values for quantity of heat, tariff register, volume, maximum demand and missing time, previous year's values for quantity of heat, volume and maximum demand, measuring period with maxima for demand, flow rate and temperatures, actual values for demand, flow rate and temperatures, setting and resetting of a user protection, setting of the date and time, setting of the primary and secondary address.

*) Special version with updating every 30 s available (WZR-MP-30), but with reduced battery life

Data for fast read-out:

Updating no later than every 4 sec;

Property number, quantity of heat, volume

Actual value for demand, flow rate, temperatures

Setting of the date and time.

Attention: Fast readout is only allowed together with a 6-year D-cell or a power supply module.

Combi module M-Bus + pulses

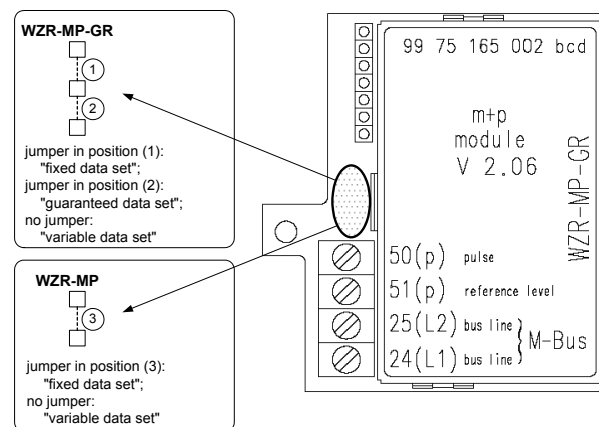

The combi module M-bus+pulses is used if data of the 2WR5 heat meter is processed in a master-capable M-bus unit and at the same time pulses are to be transmitted to systems or district heating controllers for limitation and closed-loop control.

Display on LCD **MB** (as with M-bus module).

For further technical data see M-bus module or fast pulses.

The pulse module enables the heat meter to communicate with

- The M-bus central unit, e.g. OZW10
- Further master-capable M-bus compatible systems (e.g. regulators using fast read-out)
- Further devices or systems equipped with pulse interfaces

The combi module performs the following functions:

- Reading out data from the heat meter and transmitting them via the M-bus
- Configuring the heat meter via the M-bus (e.g. setting the time and date)
- Closed-loop control in systems on the basis of the current system values using pulses proportional to the volume or energy. The module delivers the so called fast pulses and no standard pulses. It therefore needs to be parametrised with software PappaWin.
- Limitation to maximum consumption values

The heat meter detects the module plugged in and the transmission rate of the M-bus communication (300 baud or 2400 baud) automatically.

Modem module

The analogue modem allows for reading the meter data and setting of meter date and time. It can be called as well as call itself a settable number at settable times.

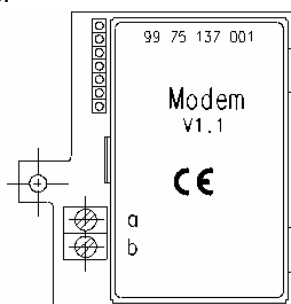

Technical design

The modem takes its energy from the telephone network. It does not use any battery or accumulator and is therefore maintenance free. It can operate in parallel to an analogue telephone.

With password protection for readout and administration.

A call back number and 10 call back times or one call back interval can be set remotely.

Display in LCD	MB (as with M-Bus Modul)
Standard	TBR21/CTR21
Protocol	EN 61107
Baudrate	1200 baud, V.22 (V.22bis)
Isolation	galvanic (3700V rms)
Connection	2-conductor, 2 x 0,75mm ²
Polarity	no (possibly yes in private telephone networks)
Literature	TKB 3416

Data content:

As with the CL- module, but reduced to 24 monthly values due to the limited storage capacity of the modem.

Analog module

The analog module converts the measured quantity from the heat meter to an analog signal. Parameterization (selection of measured quantity and output measuring range) is performed with the coding switches (A, B, C, D) on the module.

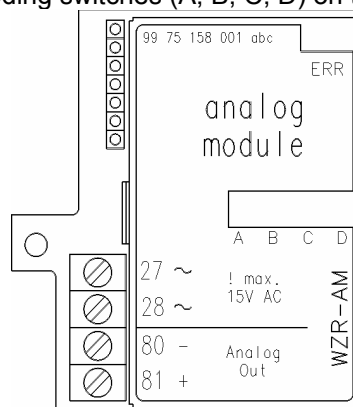

The output signal is updated (by polling) every four seconds.

A light-emitting (ERR) diode displays the current operating status.

Display in LCD **MB** (as with M-Bus Modul)

Output

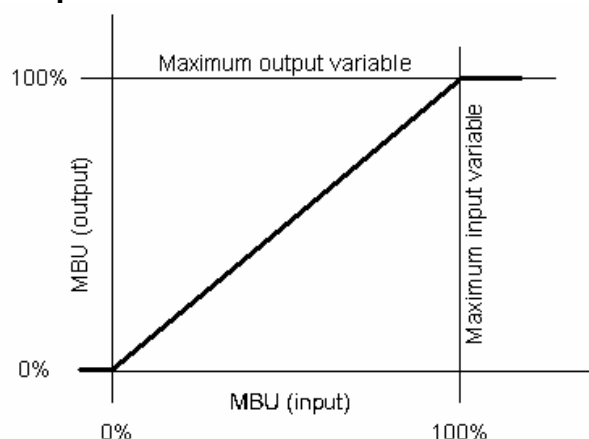

*positive input values above max. input variable (overrange) are displayed as a maximum value (100%);

*negative input values are displayed as zero (0%)

Power supply

An external plug-in power supply unit supplies the module with power (not included in the scope of supply of the module). In case of battery-powering a battery of type D ("for all applications") is necessary.

The CE-compliance is only warranted when the suggested power supply is used (see ordering data).

Only use the **power supply module specified!** If an unsuitable power supply module is used, it may cause the heat meter or module to malfunction or damage it.

Analog Output

The voltage output is not short-circuit proof. A maximum load of 100 ohms is permitted for the current output.

Radio module

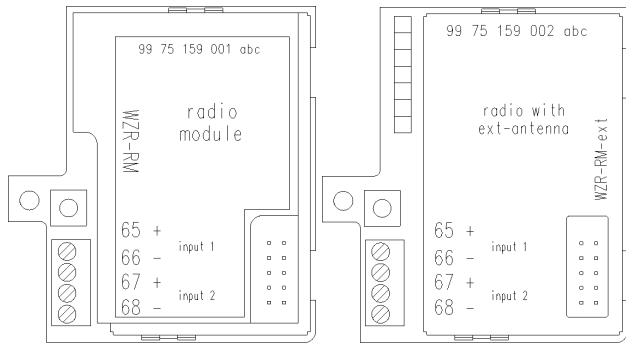

By means of its integrated antenna the radio module permits wireless read-out from distances of up to 100 meters. For special installation situations, the radio module can be supplied in a version with an external antenna.

The module is programmed via radio telegrams. The transmit parameters can be reset to default values via a pushbutton.

Two LEDs automatically indicate the operating status of the module.

The module is powered via the heat meter. If using battery power, a 6-year battery of type D ("for all applications") is required.

To reduce power consumption, the sampling rate can be lengthened or the transmission power can be reduced.

The module contains two additional pulse counters for acquisition of external metering pulses.

On the inputs for the pulse meter, please note:

- only isolated contacts (Reed contacts, no open collector) may be connected
- no galvanic isolation from the electronics of the heat meter
- external power source or grounding not permitted

Display in LCD MB (as with M-Bus-Modul).

Technical data radio:

Frequency: 433 MHz
 Transmission power: 8 mW / 5 mW
 Range: up to 100 meters
 (with integrated antenna)
 Sampling rate: 8 seconds / 1 minute;
 can be changed with jumper
 Read-out frequency: max. 1 read-out per day
 (average)

Technical data counter:

Pulse meter: 2 inputs for external pulses
 Terminals: for wires measuring 0.25 to
 0.50 mm², max. 0.75 mm²
 Meter range: 0...99 999 999
 Weighting factor: 0,001...999,999
 Meter ID: 8 digits
 Min. pulse length: 50 ms
 Max. pulse sequence: 5 pulses/s (2 inputs used)
 10 pulses/s (1 input used)

For each data request the module reads both the heat meter data and the counter data.

The data are packed into different types of telegram and issued.

The heatmeter in this case must work in normal mode.

Content of telegrams

All of the telegrams consist of a header, including date and time stamp and customer number.

Type of telegram:	Content:
"Basic"	Cumulated values and error status
"Preview year"	Cumulated previous year's values and error status
"Preview month"	Cumulated previous month's values and error status
"Extended"	Current instantaneous values, stored maximum values and error status
"Pulse and service"	Counter data

Engineering

- The regulations for the use of heat meters must be complied with, see EN 1434 part 6! Particularly cavitation in the system must be avoided.
- Heat meters up to DN25 may only be installed with direct immersed sensors according to German calibration law!
- All information given in the data sheet of the heat meter must be observed.
- User seals may only be removed by authorized staff carrying out service work. They must be replaced afterwards.
- The module is supplied with mounting and commissioning instructions.
- No later than 4 seconds after mounting, the heat meter automatically detects the plugged-in module and is ready for communication or pulse output.
- The type of module plugged in can be displayed depending on the display parameterization in the service loop.
- Setting the parameters of the heat meter for the fast pulses can be done by using the PappaWin software.
- Latest information you may find in the internet: www.landisgyr.com

Landis+Gyr GmbH
 Humboldtstr. 64
 D-90459 Nürnberg
 Germany

Pressure drop of 2WR5

